

DMP 320

Precision Pressure Transmitter with Fast Response Time

Stainless Steel Sensor

accuracy according to IEC 60770:
0.1 % FSO



Nominal pressure

from 0...100 mbar up to 0...600 bar

Output signal

3-wire: 0.1 ... 10 V
4 ... 20 mA

others on request

Special characteristics

- ▶ extremely fast
response time ≤ 0.5 msec
- ▶ internal sample rate 10 kHz
- ▶ accuracy 0.1 % FSO
- ▶ excellent thermal behaviour
- ▶ outstanding long term stability

Optional versions

- ▶ customer specific versions

DMP 320 stands for speed and precision.

With a response time of ≤ 0.5 msec and a sampling rate of 10 kHz, the pressure transmitter was designed for applications, in which an extremely fast and exact pressure measuring is required. Pressure curves, peaks and hits can be monitored and evaluated exactly.

The signal processing of the sensor signal is done by newly developed digital electronics, which detect the signal with a sampling rate of 10 kHz. Sensor-specific deviations such as non-linearity, hysteresis and temperature errors are compensated actively.

Preferred areas of use are



Plant and machine engineering



Energy industry



Input pressure range												
Nominal pressure gauge [bar]	-1...0	0.10	0.16	0.25	0.40	0.60	1	1.6	2.5	4	6	
Nominal pressure abs. [bar]	-	-	-	-	0.40	0.60	1	1.6	2.5	4	6	
Overpressure [bar]	5	0.5	1	1	2	5	5	10	10	20	40	
Burst pressure ≥ [bar]	7.5	1.5	1.5	1.5	3	7.5	7.5	15	15	25	50	

Nominal pressure gauge / abs [bar]	10	16	25	40	60	100	160	250	400	600	
Overpressure [bar]	40	80	80	105	210	600	600	1000	1000	1000	
Burst pressure ≥ [bar]	50	120	120	210	420	1000	1000	1250	1250	1250	
Vacuum resistance	$p_N \geq 1$ bar: unlimited vacuum resistance $p_N < 1$ bar: on request										

Output signal / Supply	
3-wire voltage	0.1 ... 10 V / $V_S = 14 ... 30 V_{DC}$
3-wire current	4 ... 20 mA / $V_S = 14 ... 30 V_{DC}$

Performance	
Accuracy ¹	$\leq \pm 0.1$ % FSO
Permissible load	current 3-wire: $R_{max} = 500 \Omega$ voltage 3-wire: $R_{min} = 10 k\Omega$
Influence effects	supply: 0.05 % FSO / 10 V load: 0.05 % FSO / k Ω
Long term stability	$\leq \pm 0.1$ % FSO / year at reference conditions
Response time	≤ 0.5 msec

¹ accuracy according to IEC 60770 – limit point adjustment (non-linearity, hysteresis, repeatability)

Thermal effects (offset and span)	
Tolerance band	$\leq \pm 0.2$ % FSO
TC, average	± 0.02 % FSO / 10 K
in compensated range	-20 ... 80 °C

Permissible temperatures	
Medium	-40 ... 125°C
Electronics / environment	-40 ... 85°C
Storage	-40 ... 100°C

Electrical protection	
Short-circuit protection	permanent
Reverse polarity protection	no damage, but also no function
Electromagnetic compatibility	emission and immunity according to EN 61326

Mechanical stability	
Vibration	10 g RMS (25 ... 2000 Hz) according to DIN EN 60068-2-6
Shock	500 g / 1 msec according to DIN EN 60068-2-27

Materials	
Pressure Port	stainless steel 1.4404 (316 L)
Housing	stainless steel 1.4404 (316 L)
Option compact field housing	stainless steel 1.4301 (304) cable gland M12x1.5, brass, nickel plated (clamping range 2 ... 8 mm)
Seals	standard: FKM options: EPDM others on request
Diaphragm	stainless steel 1.4435 (316 L)
Media wetted parts	pressure port, seals, diaphragm

Miscellaneous	
Current consumption	3-wire voltage: < 30 mA 3-wire current: < 55 mA
Weight	approx. 200 g
Installation position	any ²
Operational life	100 million load cycles
CE-conformity	EMC Directive: 2014/30/EU Pressure Equipment Directive: 2014/68/EU (module A) ³

² Pressure transmitters are calibrated in a vertical position with the pressure connection down. If this position is changed on installation there can be slight deviations in the zero point for pressure ranges $p_N \leq 1$ bar.

³ This directive is only valid for devices with maximum permissible overpressure > 200 bar

DMP 320

Precision Pressure Transmitter

Technical Data

Wiring diagram

3-wire-system (current / voltage)

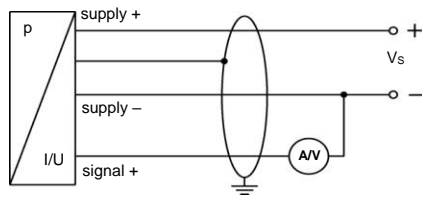

Pin configuration

Electrical connection	ISO 4400	Binder 723 (5-pin)	M12x1 / metal (4-pin)	compact field housing	cable colours (IEC 60757)
Supply +	1	3	1	V _{S+}	WH (white)
Supply -	2	4	2	V _{S-}	BN (brown)
Signal +	3	1	3	S+	GN (green)
Shield	ground pin	5	4	GND	GNYE (green-yellow)

Electrical connections (dimensions mm / in)

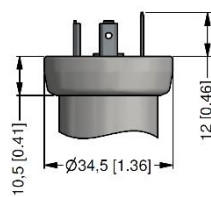

ISO 4400 (IP 65)

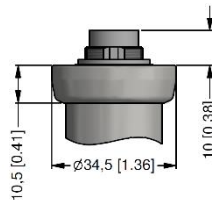

Binder series 723, 5-pin (IP 67)

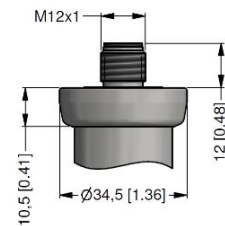

M12x1, 4-pin (IP 67)

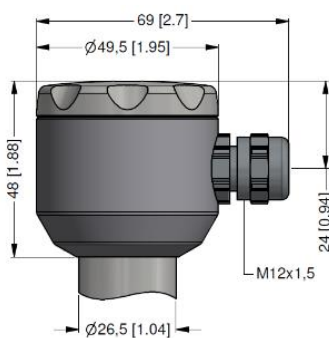

compact field housing (IP 67)

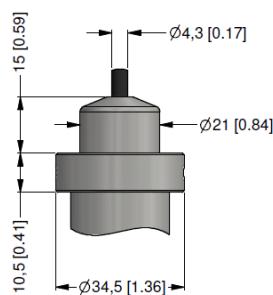

cable outlet with PVC-cable (IP 67)⁴

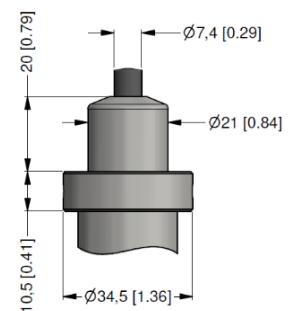

cable outlet, cable with ventilation tube (IP 68)⁵

⇒ universal field housing stainless steel 1.4404 (316 L) with cable gland M20x1.5 (ordering code 880) and other versions on request

⁴ standard: 2 m PVC cable without ventilation tube (permissible temperature: -5 ... 70 °C)

⁵ different cable types and lengths available, permissible temperature depends on kind of cable

DMP 320

Precision Pressure Transmitter

Technical Data

Dimensions (mm / in)

* for nominal pressure $p_N > 40$ bar the length of devices increases by 9 mm

Mechanical connections (dimensions mm / in)

<p>G1/2" DIN 3852</p>	<p>G1/2" EN 837</p>	<p>1/2" NPT</p>
<p>G1/4" DIN 3852</p>	<p>G1/4" EN 837</p>	<p>1/4" NPT</p>
<p>G1/2" open port DIN 3852 ($p_N \leq 40$ bar)</p>		

⇒ metric threads and other versions on request

© 2021 BD|SENSORS GmbH – The specifications given in this document represent the state of engineering at the time of publishing. We reserve the right to make modifications to the specifications and materials.

DMP320_E_041021

Tel.: +49 (0) 92 35 / 98 11- 0
 Fax: +49 (0) 92 35 / 98 11- 11

www.bdsensors.de
 info@bdsensors.de

BD|SENSORS
 pressure measurement

Ordering code DMP 320

DMP 320

--	--	--	--	--	--	--	--	--	--	--	--	--	--	--	--	--	--	--	--	--

Pressure																				
	gauge	1	1	C																
	absolute ¹	1	1	D																
Input																				
	[bar]																			
	0.10 ¹				1	0	0	0												
	0.16 ¹				1	6	0	0												
	0.25 ¹				2	5	0	0												
	0.40				4	0	0	0												
	0.60				6	0	0	0												
	1.0				1	0	0	1												
	1.6				1	6	0	1												
	2.5				2	5	0	1												
	4.0				4	0	0	1												
	6.0				6	0	0	1												
	10				1	0	0	2												
	16				1	6	0	2												
	25				2	5	0	2												
	40				4	0	0	2												
	60				6	0	0	2												
	100				1	0	0	3												
	160				1	6	0	3												
	250				2	5	0	3												
	400				4	0	0	3												
	600				6	0	0	3												
	-1 ... 0				X	1	0	2												
	customer				9	9	9	9												consult
Output																				
	0,1 ... 10 V / 3-wire								3A											
	4 ... 20 mA / 3-wire								7											
	customer								9											consult
Accuracy																				
	0.1 % FSO								1											
	customer								9											consult
Electrical connection																				
	male and female plug ISO 4400								1	0	0									
	male plug Binder series 723 (5-pin)								2	0	0									
	cable outlet with PVC cable (IP67) ²								T	A	0									
	cable outlet,								T	R	0									
	cable with ventilation tube (IP68) ³								T	R	0									
	male plug M12x1 (4-pin) / metal								M	1	0									
	compact field housing								8	5	0									
	stainless steel 1.4301 (304)								9	9	9									
	customer								9	9	9									consult
Mechanical connection																				
	G1/2" DIN 3852								1	0	0									
	G1/2" EN 837								2	0	0									
	G1/4" DIN 3852								3	0	0									
	G1/4" EN 837								4	0	0									
	G1/2" DIN 3852 open pressure port ⁴								H	0	0									
	1/2" NPT								N	0	0									
	1/4" NPT								N	4	0									
	customer								9	9	9									consult
Seals																				
	FKM																			1
	EPDM																			3
	customer																			9
Special version																				
	standard																			0 0 0
	customer																			9 9 9
																				consult

¹ absolute pressure possible from 0.4 bar

² standard: 2 m PVC cable without ventilation tube (permissible temperature: -5 ... 70 °C); others on request

³ code TR0 = PVC cable, cable with ventilation tube available in different types and lengths

⁴ only for P_N ≤ 40 bar